



BLUE LOGIC

OPERATION AND MAINTENANCE MANUAL

DOCUMENT TITLE: Operation and Maintenance Manual Ø43 API 17H 3rd edition
Type 1 Hot Stab Program
PROJECT TITLE: 600102- Ø43-Hot Stab System
PROJECT: 600102
PACKAGE DESCRIPTION: Ø43 API 17H 3rd edition Type 1 Hot Stab Program
DOCUMENT NUMBER: 600102-TD-0002
REV: 08
NUMBER OF PAGES: 25

DATE: 09.06.2022

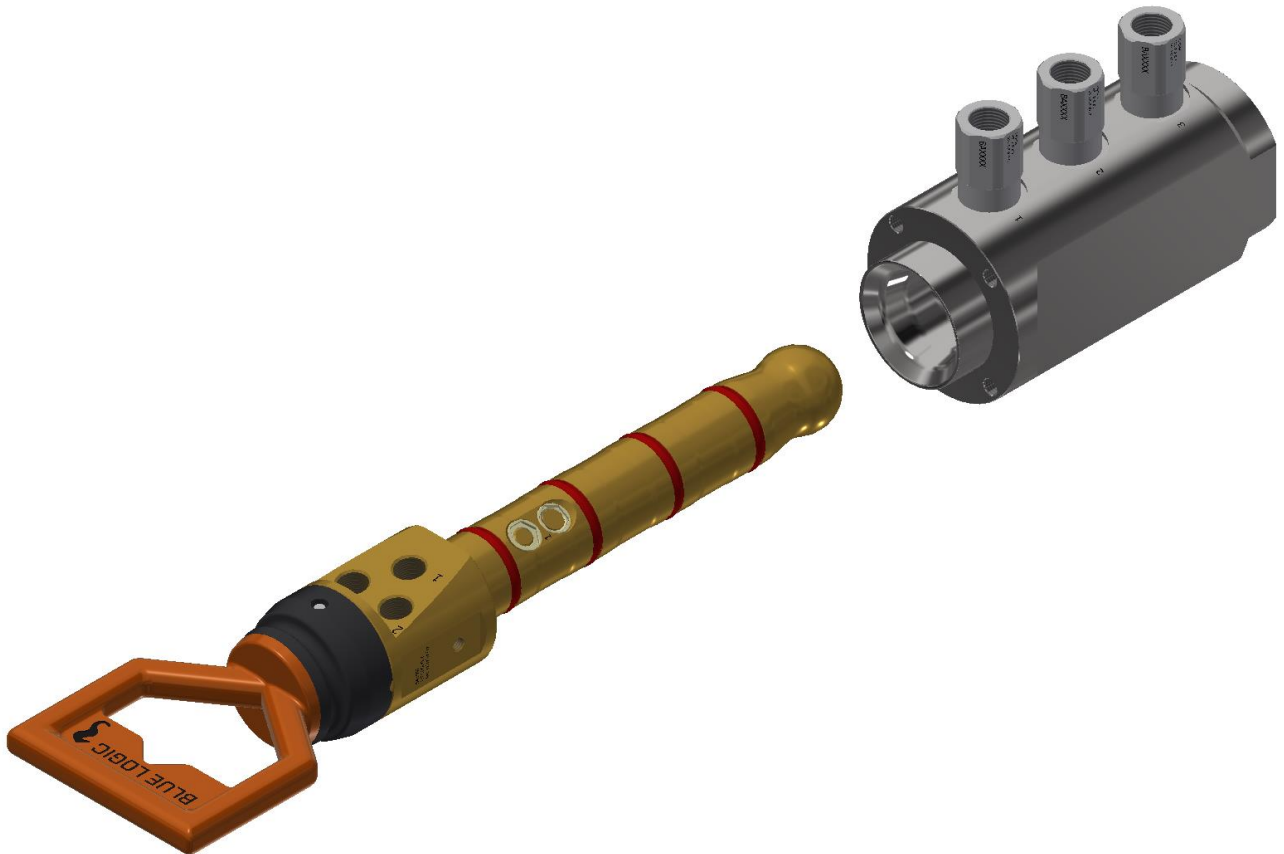



OPERATION AND MAINTENANCE MANUAL

OBJECTIVE

The objective of this document is to present a comprehensive Operation and Maintenance Manual for the Ø43 Hot Stab Program delivered by Blue Logic AS. All relevant aspects with regards to safe and correct use, installation, operation, maintenance and storage are covered.

ABSTRACT

The Blue Logic Ø43 Type 1 Hot Stab program is designed in accordance with API 17H 3rd edition Type 1 (Old ISO 13628-8 Type B). The program includes single port, dual port, triple port and quad port stabs/receptacles individually optimized for flow or pressure. For full program overview and further technical details, please visit: <http://e-sea.bluelogic.no/main.aspx>

REVISION CHANGE/RECORD

REV	REASON FOR REVISION/ DESCRIPTION OF CHANGES
01	Document initiated, Prepared and Issued as general information
02	Updated PCD from Ø80 to Ø86 on receptacle
03	Added Information regarding receptacle check valve replacement
04	Update according to API 17H 3 rd edition
07	Add check valve replacement info/warning
08	20K Hot Stab Program included



OPERATION AND MAINTENANCE MANUAL

TABLE OF CONTENT

1. INTRODUCTION	5
1.1. DOCUMENT USE	5
1.2. REFERENCES	5
1.3. ABBREVIATIONS	5
2. TECHNICAL DESCRIPTION	6
2.1. GENERAL	6
2.2. FEATURES	6
2.3. DESIGN AND TEST	6
2.4. TECHNICAL PERFORMANCE	7
2.5. HOT STAB	8
2.5.1. Hydraulic Ports	8
2.5.2. Strain Relief System	9
2.5.3. Locking Mechanism	10
2.6. RECEPTACLE	11
2.6.1. Hydraulic Ports	12
2.7. PROTECTION STAB	13
2.8. PRESSURE STAB	13
3. INSTALLATION	14
3.1. RECEPTACLE	14
3.1.1. Adapter plate for Receptacle	15
4. OPERATION	16
4.1. PRE-DIVE CHECK	16
4.1.1. Hot Stab	16
4.1.2. Receptacle	16
4.2. CONNECTION	17
4.3. DISCONNECTION	17
4.4. POST DIVE CHECK	17
5. MAINTENANCE	18
5.1. SEAL REPLACEMENT	18
5.1.1. Removal of Seal	18
5.1.2. Installation of new Seal	18
5.1.3. Installation of new Seal Using Seal Replacement Tool	19
5.2. ROV INTERFACE	21
5.3. CHECK VALVES	21
5.3.1. Receptacle Check Valves	21
Hot Stab Check Valves	23
5.3.2. Hot Stab Check Valves	
5.4. FLEX JOINT	24
5.5. SPARE PARTS	24

6.	STORAGE AND TRANSPORT	25
6.1.	PRESERVATION FOR STORAGE.....	25
6.2.	TRANSPORT	25

1. INTRODUCTION

The Blue Logic Ø43 Hot Stab Program is designed in accordance with API 17H 3rd edition Type 1. The program covers all relevant subsea applications and use for both intervention and permanent installations. Typical use for the Ø43 Hot Stab program:

- ROV Panels
- Umbilical termination systems
- MEG distribution
- Hydraulic connection between ROV/ROT and dedicated tools.

The hot stabs are available with design pressure 207, 345, 690, or 1380 bar and are individual optimized with regards to flow as a function of design pressure and number of ports accordingly.

For a complete program overview, please visit: <http://e-sea.bluelogic.no/main.aspx>

1.1. DOCUMENT USE

This document shall be used as a guideline and reference document with regards to installation, operation and storage of the Ø43 Type 1 Hot Stab System.

1.2. REFERENCES

<http://e-sea.bluelogic.no/main.aspx>

1.3. ABBREVIATIONS

ROV:	Remotely Operated Vehicle
HPU:	Hydraulic Power Unit
FAT:	Factory Acceptance Test
SP	Single Port
DP	Dual Port
TP	Triple Port
QP	Quad Port

2. TECHNICAL DESCRIPTION

2.1. GENERAL

In addition to various and different company specific "standards" for Hot Stabs, there are several different national and international recognised standards describing both design and construction of such equipment. The most common and international standards up to release of API 17H 3rd edition, are API 17D and ISO 13628-8. In general, these standards are based on designs using nominal outer stab diameter of Ø28, Ø35 and Ø43mm.

These types are now superseded by the following in API 17H 3rd edition:

- Type 1: Single Bore Multiport (non-taper design)
- Type 2: Dual Bore Multiport (taper design)

The Blue Logic Hot Stab system is equipped with integrated check valves installed directly into the Hot Stab body. Typically, there are two single acting valves for each hydraulic port in the stab (in + out) and a double acting check valve in the hot stab receptacle.

The use of integrated check valves allows for subsea and topside connection/ disconnection of the stab system with minimum leakage and water ingress in the hydraulic system. For some applications where extreme flow performances are required check valves can be omitted, thus decreasing pressure loss in the stab system.

2.2. FEATURES

- Dual Single acting check valves integrated in each hydraulic port allows for superior flow performance without compromising stab strength and leakage rates.
- Integrated and unique flex joint design with excellent flexibility performance and high strength by use of special durable polymeric material.
- Replaceable flex joint element
- Optimised for flow performance and minimum pressure drop for each individual pressure rating and port configuration.
- Compact design due to integrated flex joint system with reduced overall length
- Material selection optimised for type of use and design requirements. Selected for excellent performance and increased lifetime (both for permanent installation and intervention applications)

2.3. DESIGN AND TEST

The Blue Logic Ø43 Hot Stab program are calculated, designed, tested and documented in accordance with API6A (ISO10423) with regards to material usage and pressure test. All Hot Stab equipment is pressure tested to 1.5 x Design Pressure except the 20K system which is pressure tested to 1,25 x DP.

2.4. TECHNICAL PERFORMANCE

The Blue Logic Ø43 Hot Stabs are Based on API 17H 3rd edition Type 1 (Old API 17H and ISO 13628-8 type B) and comes in different types and configuration. Hot Stabs for Permanent use, ROV use, with check valves and different pressure ratings. What is important to consider when selecting a Hot Stab is the flow capacity. As the flow increase you will experience pressure loss over the connection. This means that you will have less pressure available for the hydraulic work. We recommend that the maximum flow of a Ø43 Hot Stab with check valves is approx. 50 l/min. For the 20K system, maximum flow is approx. 35l/min.

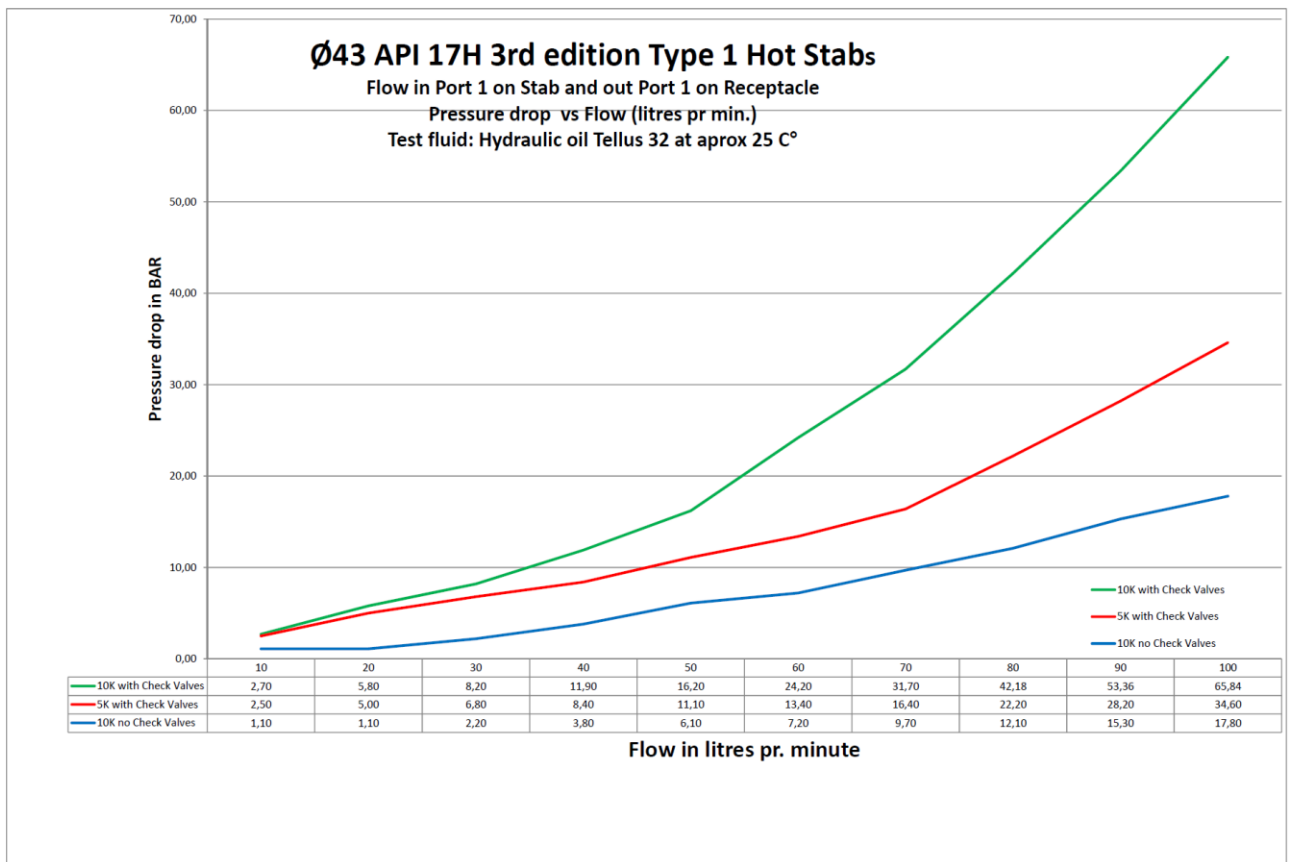

Figure 1 Typical Pressure vs Flow diagram Ø43 Hot Stab

2.5. HOT STAB

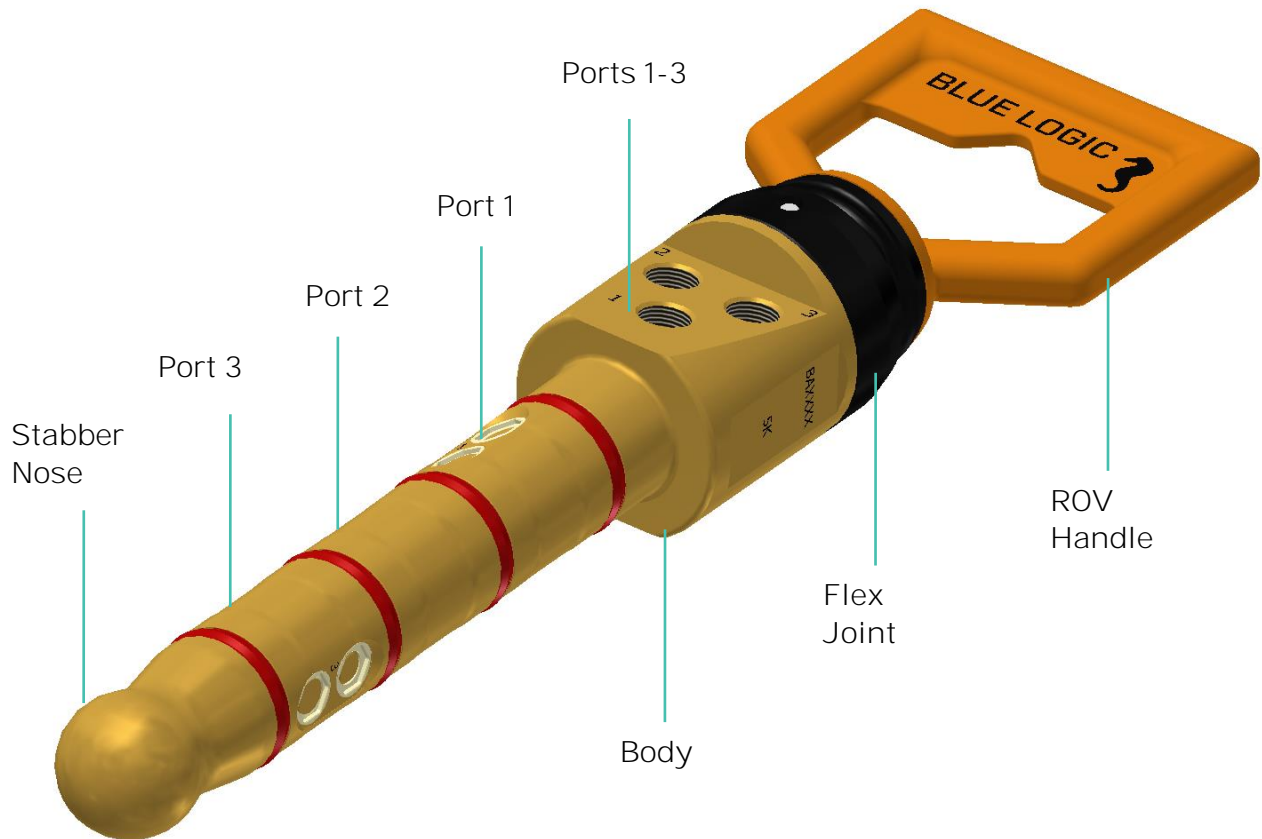

Figure 2 Typical Triple Port Ø43 Hot Stab

2.5.1. Hydraulic Ports

The Ø43 Hot Stabs are available with 1, 2, 3 and 4 separate hydraulic ports. In general terms these are described as "single", "dual", "triple" and "quad" – port Hot Stabs.

The port sizes and connection type vary. Please see associated product drawing for details with regards to threads and interface information on hydraulic ports. Port numbers are engraved directly into the stabber body besides the hydraulic connection. Numbering is in accordance with figure above.

For detailed product drawings, please visit: <http://e-sea.bluelogic.no/main.aspx>

2.5.2. Strain Relief System

To reduce hose strain and to protect from potential overload during operation, a wire system can be strapped onto the hoses and secured in an eye bolt on the hot stab. The eye bolt is delivered as optional equipment from Blue Logic upon request or can be purchased as a standard item. Hot stab interface for the strain relief eye bolt is M8 x 14 mm



Figure 3 Typical Strain Relief Wire

2.5.3. Locking Mechanism

As an option, all Blue Logic Ø43 Hot Stab equipment can be delivered with ROV Operated locking mechanism thus securing the hot stab into the receptacle. The locking mechanism are installed and bolted directly onto the stabber body, and locks onto the Adapter plate for Receptacle described in chapter 3.1.1

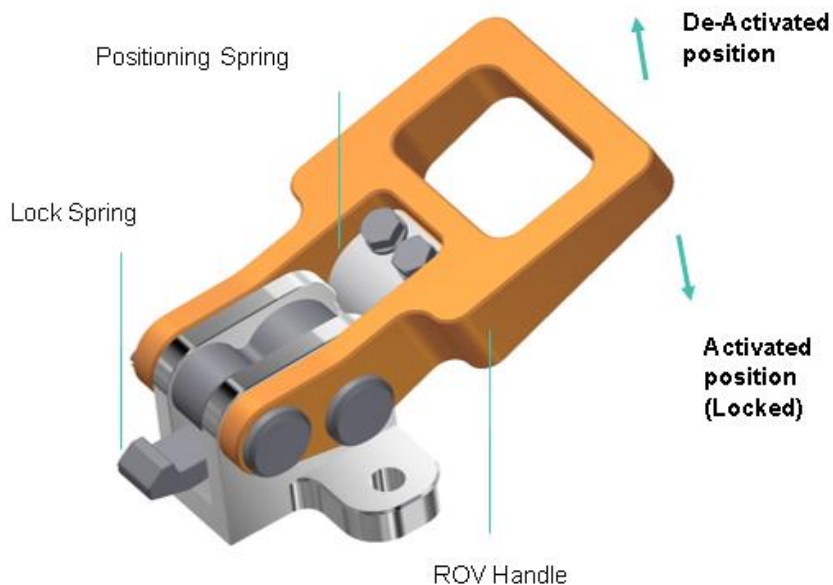

Figure 4 Locking Mechanism

The lock has two positions; Activated and De-activated;

Activated: When the lock is placed in "Activated position", the stab can be inserted directly into the receptacle and lock automatically when fully inserted. Holding force approx. 3kN

De-activated: Lift the handle out from the stabber body. The hot stab can be pulled out from the receptacle.

2.6. RECEPTACLE

The Ø43 API 17H 3rd edition Type 1 receptacles consist of one receptacle body and separately installed double acting check valves. The receptacles are normally installed in a ROV panel or bracket from the rear side. As an alternative, a special designed adapter plate can be delivered for front mounting in the ROV panel. The Blue Logic standard receptacles are delivered in Super Duplex material.

The standard receptacle design allows for direct installation into ROV Panels with a thickness up to 20mm.

For further technical details, please visit: <http://e-sea.bluelogic.no/main.aspx>

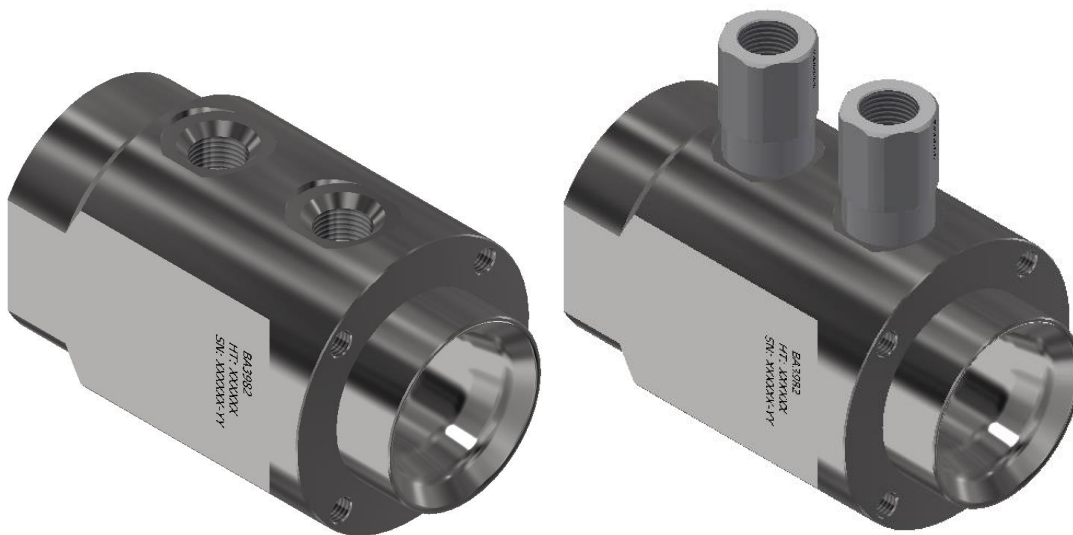

Figure 5 Typical example of Ø43 DP receptacle with and without check valves

2.6.1. Hydraulic Ports

The Ø43 Hot Stab Receptacles are available with 1, 2, 3 and 4 separate hydraulic ports. In general, terms these are described as "single", "dual", "triple" and "quad" – port receptacles.

The port sizes and connection type vary. Please see associated product drawing for details concerning threads and interface information on hydraulic ports. Port numbers are engraved directly into the receptacle body besides the hydraulic connection. Numbering is in accordance with below figure.

For detailed product drawings, please visit: <http://e-sea.bluelogic.no/main.aspx>



Figure 6 Typical Hydraulic Port numbering

2.7. PROTECTION STAB

Protection stabs are delivered for permanent installation, both vented and non-vented versions.



Figure 7 Typical Ø43 Triple Port Protection Stab

2.8. PRESSURE STAB

Pressure stabs can be delivered both for intervention and permanent installation.

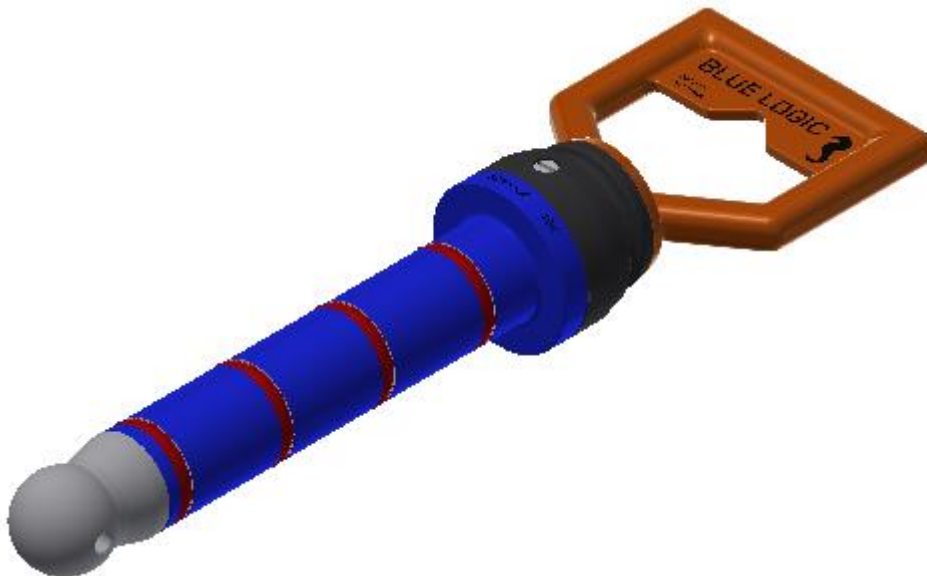

Figure 8 Typical Ø43 Triple Port Pressure Stab



3. INSTALLATION

3.1. RECEPTACLE

The Hot Stab receptacle can be installed in several different ways, typically in a ROV panel or in a dedicated bracket. The Ø43 receptacle can be rear mounted in ROV panels with thickness up to 20mm without need for an additional adapter plate. This adapter plate also includes interface for the optional ROV operated Hot Stab Locking mechanism. Alternatively, the dedicated adapter plate can be used for front installation giving no restrictions with regards to ROV Panel thickness. For all alternatives, Blue Logic recommends using segregated lock washers to ensure electrical contact between panel, receptacle and fasteners. Electrical contact between these parts should always be verified prior to subsea use.

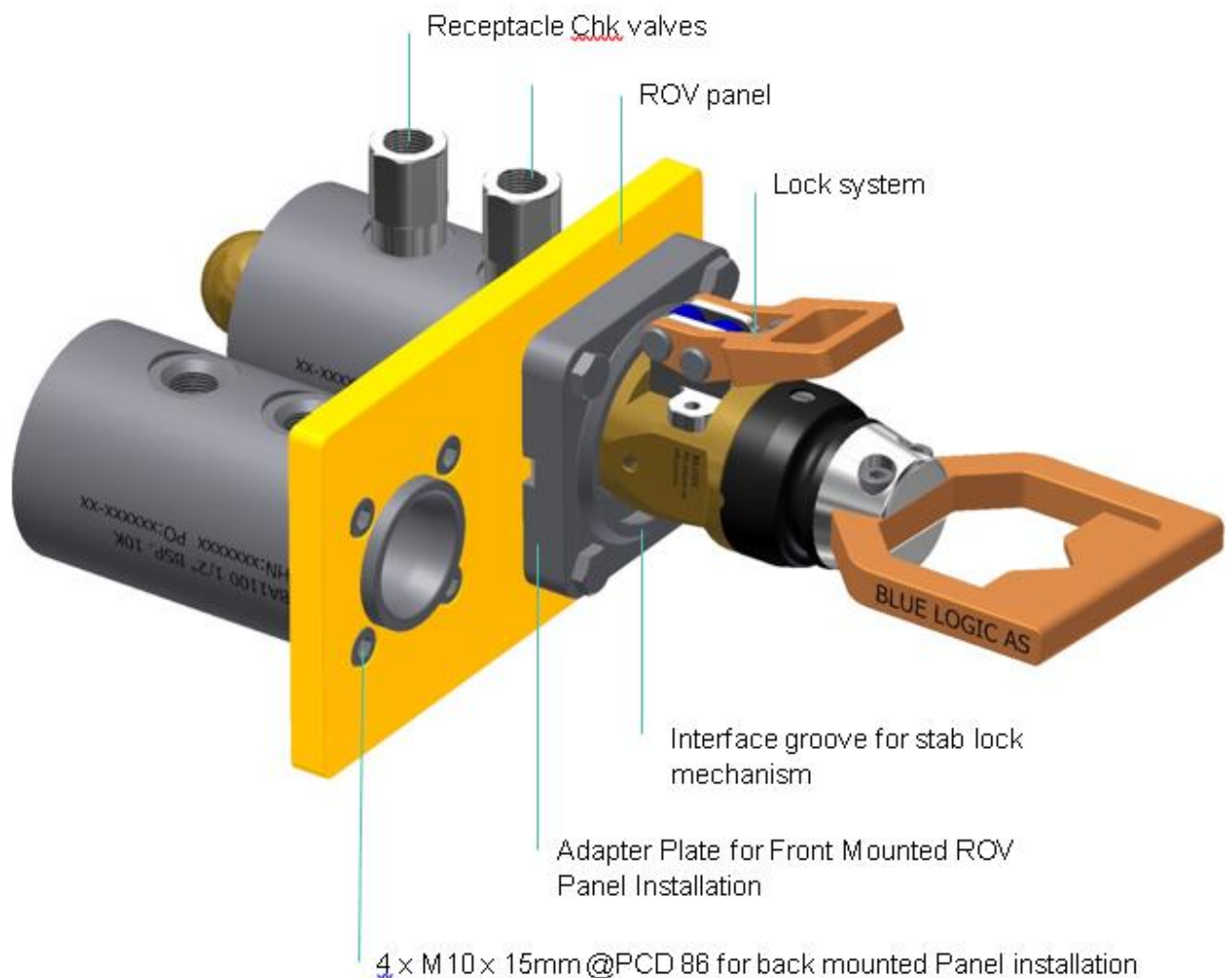

Figure 9 Receptacle Panel Installation examples

3.1.1. Adapter plate for Receptacle

The Receptacle Adapter Plate enables installation of the receptacle onto panels with $t > 20\text{mm}$. In addition, this adapter plate also includes interface for the Blue Logic Standard Hot Stab Lock System as described in following sections. As a rule, electrical connection between all parts and panel should be secured and verified by use of segregated locking washers or similar.

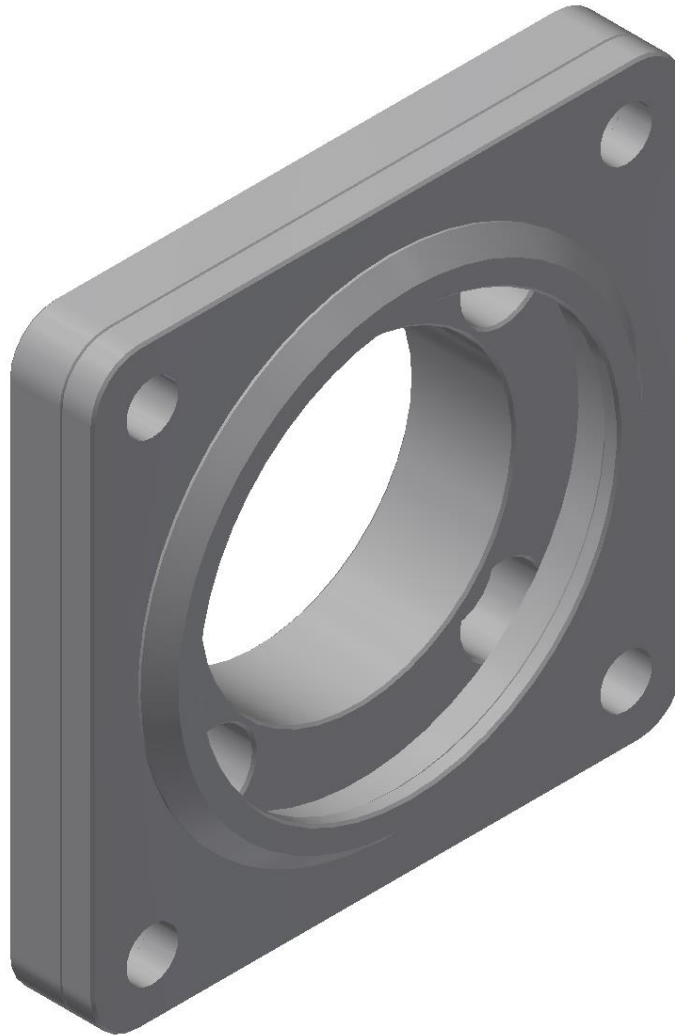

Figure 10 Adapter Plate for Front Mounted ROV Panel Installation



4. OPERATION

Warning:

Prior to operation, verify that the Hot Stab equipment corresponds with the interfacing system with respect to pressure rating. Mixing of equipment with different pressure ratings may cause personal injuries and/or damages to equipment.

4.1. PRE-DIVE CHECK

4.1.1. Hot Stab

No.	Description	Chk/Verified
01	Verify correct pressure rating	
02	Verify all fittings and hoses correct installed and secured	
03	Verify no leakages from hoses and connections	
04	Inspect all seals for damage. Replace if required	
05	Inspect Hot stab nose and body for mechanical damages and harmful scratches	
06	Inspect ROV handle for damages	
07	Inspect flex joint properly secured to stab body and ROV handle	
08	Verify functionality of flex joint. Ensure free to bend in all directions	
09	Inspect all check valves visually for damages and scratches, verify correct installed.	
10	Inspect all check valves for leakage	
11	Verify functionality of the locking system (Optional equipment)	

4.1.2. Receptacle

No.	Description	Chk/Verified
01	Verify correct pressure rating	
02	Visual inspect receptacle internal surface finish and entrance area if possible.	
03	Ensure correct installation of the receptacle and free distance for hot stab guide nose behind rear receptacle opening	
04	Verify no leakages from hoses, piping and receptacle check valves.	
05	Verify ROV access and free space in front of receptacle and panel.	



OPERATION AND MAINTENANCE MANUAL

4.2. CONNECTION

The Hot Stab can be inserted directly into the receptacle without special preparations independent of axial rotation. The Stab can also be inserted into the receptacle from both ways.

During insertion of the Hot Stab into the Receptacle there will be friction between Receptacle and stab seal system. Approximate stab force is 50N for each port max. Hydraulic oil, lubrication or water will however reduce this friction significantly.

If the Hot Stab is equipped with ROV operated locking system, the Hot Stab can be inserted into the Receptacle independently of locking position. Note however that if the lock is placed in "Activated" an additional stab force of approx. 100N is required when the lock spring enters the lock grove in the adapter plate.

4.3. DISCONNECTION

If the Stab system is equipped with locking mechanism, this shall be set in De-Activated position. No other procedures are required, and the Hot Stab can be easily pulled out from the Receptacle.

Note; prior to disconnection, hydraulic pressure in the system should be bled off in order reduce leakages to the environment. Since the Hot Stab system is a pressure balanced connection system, disconnection can be performed independently of system pressure.

Note; stab force will increase significantly if the system is pressurised.

4.4. POST DIVE CHECK

No.	Description	Chk/Verified
01	Inspect all fittings and hoses for damages and loose connection	
02	Inspect all seals for damage. Replace if required	
03	Inspect Hot stab nose and body for mechanical damages and harmful scratches	
04	Inspect ROV handle for damages	
05	Inspect flex joint, verify functionality	
06	Inspect all check valves visually for damages and scratches, verify correct installed.	
07	Verify functionality of the locking system (Optional equipment)	
08	Inspect tension relief wires and connection	
09	Clean all equipment and flush thoroughly with fresh water	
10	Dry the Hot Stab by use of pressurised air or by use of dry rags	
11	Apply preservation oil and secure in storage box.	

5. MAINTENANCE

5.1. SEAL REPLACEMENT

In standard configuration, the Blue Logic Hot Stab's are delivered with primary seal of HPU (PUR) material. These are of a special robust material and will handle numerous connections and mechanical wear and tear. This seal type has a clear red colour.

Alternative seal materials are available upon request when special requirements with regards to fluid compatibility are required.

5.1.1. Removal of Seal

In order to remove old seals on the Hot Stab; cut gently by use of a knife or similar, to split the seal. When cut, the seals can be easily removed by hand or by use of pliers.

Note; special attention should be made to avoid damages in the Stab seal area when using knives or other sharp objects.

5.1.2. Installation of new Seal



Prior to installation, new seals should be heated in hot water to approx. 80-100°C. When the seals have been heated, they can be easily pulled into the stab and inserted into the seal groove.

There are available dedicated seal replacement tools for all Blue Logic Hot Stab Systems. Following sequence describes a typical seal replacement of using these dedicated tools.

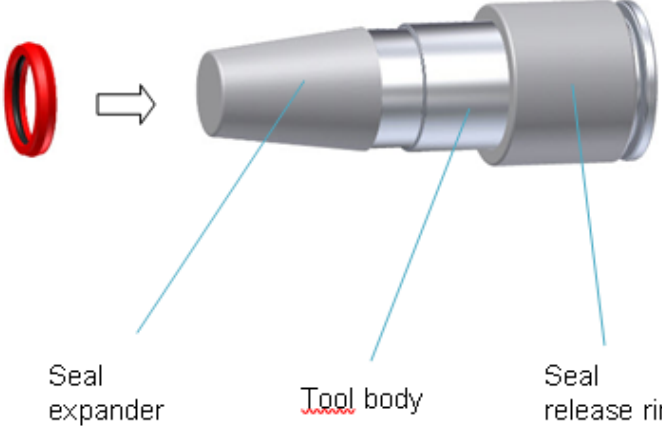
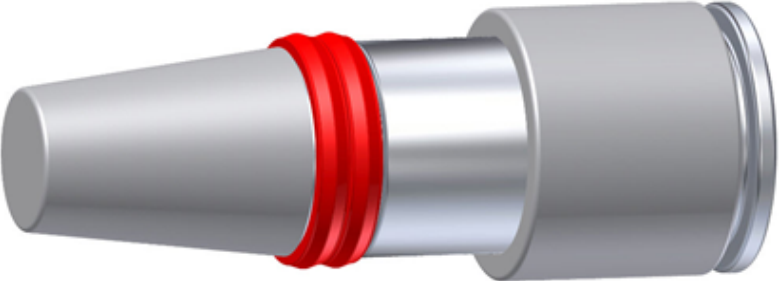

OPERATION AND MAINTENANCE MANUAL

5.1.3. Installation of new Seal Using Seal Replacement Tool

 <p>Seal expander</p> <p>Tool body</p> <p>Seal release ring</p>	<p>Remove damaged seals from stab by use of knife or nipper.</p> <p>Preheat the seals in hot water (80-100°C)</p>
	<p>Push the seals onto the tool</p> <p>There is room for 2 seals at a time.</p>
	<p>Remove the seal expander in front of tool.</p>



	<p>Slide tool onto the stab until it reaches the slot furthest in.</p>
	<p>Push the seal release ring forward while holding back the tool, until the first seal are in place.</p>
	<p>Repeat at the second slot</p>
	<p>Reassemble the seal expander</p>

Figure 11 Seal replacement Storyboard

Note; if the Seal Replacement Tool is not available, heated seals can be pulled gently onto stab directly by hand if special attention is given.

5.2. ROV INTERFACE

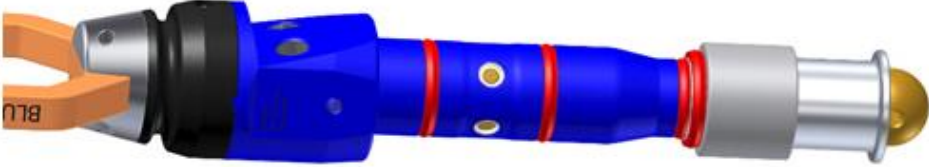
No special maintenance is required for the ROV handle/ ROV interface. Inspect for damages and replace if required.

5.3. CHECK VALVES

5.3.1. Receptacle Check Valves

The Receptacle check valves are designed for continuous use and numerous operations over several years without any maintenance or replacement. The check valves are designed with metal to metal sealing and are not 100% leak free. A leak rate of 10 drops/min are acceptable. Should however the check valve need replacement, it is recommended to return the Receptacle to Blue Logic for maintenance and check valve replacement.

⚠ Blue Logic cannot guarantee correct functionality of the check valves if replacement is performed by customer. Blue Logic Warranty is no longer valid should check valves be replaced by customer within warranty period.

The threads on the Check Valves are either BSP or NPT depending on if the receptacle is for intervention (BSP) or permanent (NPT) use. For the 20K system, threads will be of MP9/16" for all versions.

Should however an On-Site Check Valve replacement be required, the following procedure should be followed:

BSP thread version:

1. Gently heat the Receptacle and Check Valve thread area to approx. 80-100 degrees preferably by dipping the receptacle in hot water, alternatively use a heat gun to soften the Loctite 577 originally applied to the threads.
2. Special attention should be made to avoid damage to the seal system if using a heat gun.
3. Gently unscrew the check valve from the Receptacle.
4. Clean threads and remove any debris of Loctite 577.
5. Replace O-ring if damaged.
6. Apply Loctite 577 onto replacement 2-Way Check Valve threads and hand tight it into Receptacle Body. Make sure no excessive Loctite is being spilled into the 2-Way Check Valve.
7. Tighten the Check Valve to approx. 90Nm
8. Verify Check Valve Poppet movement and functionality.
9. Perform leak test to working pressure.

NPT thread version:

1. Gently heat the Receptacle and Check Valve thread area to approx. 80-100 degrees preferably by dipping the receptacle in hot water, alternatively use a heat gun to soften the Loctite 577 originally applied to the threads.
2. Gently unscrew the Check Valve from the Receptacle
3. Clean threads, and remove any debris of Loctite 577



OPERATION AND MAINTENANCE MANUAL

4. Apply Loctite 577 onto replacement 2-Way Check Valve threads and hand tight it into Receptacle Body. Make sure no excessive Loctite is being spilled into the 2-Way Check Valve.
5. Important, while tightening Check Valve into Receptacle, the Poppet must be pushed in by use of dedicated TOOL. This will prevent the Poppet from being squeezed and damaged during installation. See figure below.

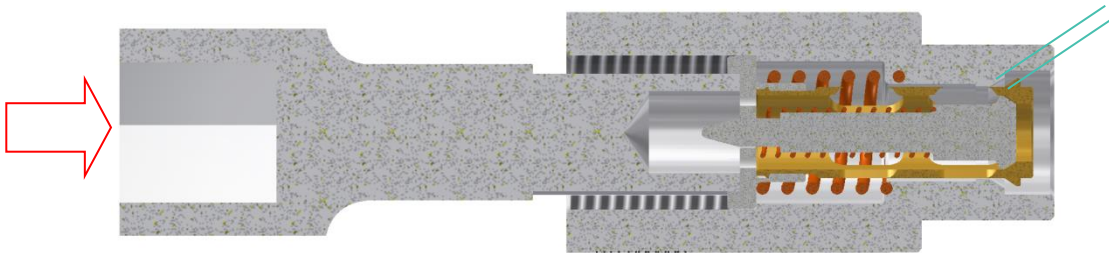

6. Tighten the Check Valve to approx. 170Nm
7. Verify Check Valve Poppet movement and functionality.
8. Perform leak test to working pressure.

MP thread version:

1. Gently heat the Receptacle and Check Valve thread area to approx. 80-100 degrees preferably by dipping the receptacle in hot water, alternatively use a heat gun to soften the Loctite 577 originally applied to the threads.
2. Gently unscrew the Check Valve from the Receptacle
3. Clean threads, and remove any debris of Loctite 577
4. Apply Loctite 577 onto replacement 2-Way Check Valve threads and hand tight it into Receptacle Body. Make sure no excessive Loctite is being spilled into the 2-Way Check Valve.
5. Tighten the Check Valve to approx. 75Nm
6. Verify Check Valve Poppet movement and functionality.
7. Perform leak test to working pressure.

5.3.2. Hot Stab Check Valves

The Hot Stabs and integrated check valves are designed for continuous use and numerous operations over several years without any maintenance or replacement. Should however the check valve need replacement, we recommend returning the Hot Stab to Blue Logic for maintenance and check valve replacement.

⚠ Blue Logic cannot guarantee correct functionality of the check valves if replacement is performed by customer. Blue Logic Warranty is no longer valid should check valves be replaced by customer within warranty period.

Should however an On-Site Check Valve replacement be required, the following procedure should be followed:

1. Gently heat the Check Valve thread area to approx. 80-100 degrees preferably by dipping the receptacle in hot water, alternatively use a heat gun to soften the Loctite 577 originally applied to the threads.
2. Special attention should be made to avoid damage to the seal system if using a heat gun.
3. By use of a 13mm Allen key, gently unscrew the check valve insert.
4. Remove all parts
5. Inspect the check valve cavity and treads for debris and damages
Prior to installation of the new check valve, apply Loctite no. 577 to the check valve threads only.
⚠ This is of vital importance as the stab can be jammed into the Receptacle if the check valves are unscrewed during use.
6. Insert check valve cartridge and parts in opposite sequence.
7. Secure the valves by applying 3-4Nm torque.
8. Verify check valve poppet movement and functionality.
9. Note that the Inlet valve consists of three different parts including spring, while the outlet valve can be removed in one piece.



OPERATION AND MAINTENANCE MANUAL

5.4. FLEX JOINT

The flex joint can be removed and replaced by the following sequence:

1. Secure the Hot Stab in a vice thus applying axial compression force between the Hot Stab body and ROV Interface according to below figure
2. Unscrew the securing pin by use of a standard screwdriver
3. Remove the securing pin
4. Remove the Hot Stab from the vice
5. Remove the Flex element and ROV handle from Hot Stab body
6. Insert the new flex joint
7. Secure the Hot Stab in a vice and apply force between the Hot Stab body and ROV interface until the securing pin can be easily inserted by hand.
8. Rotate the securing pin by use of a screwdriver and secure by applying approx. 3Nm torque.
9. Remove the Hot Stab from the Vice
10. Inspect Hot Stab and verify functionality of flex joint.

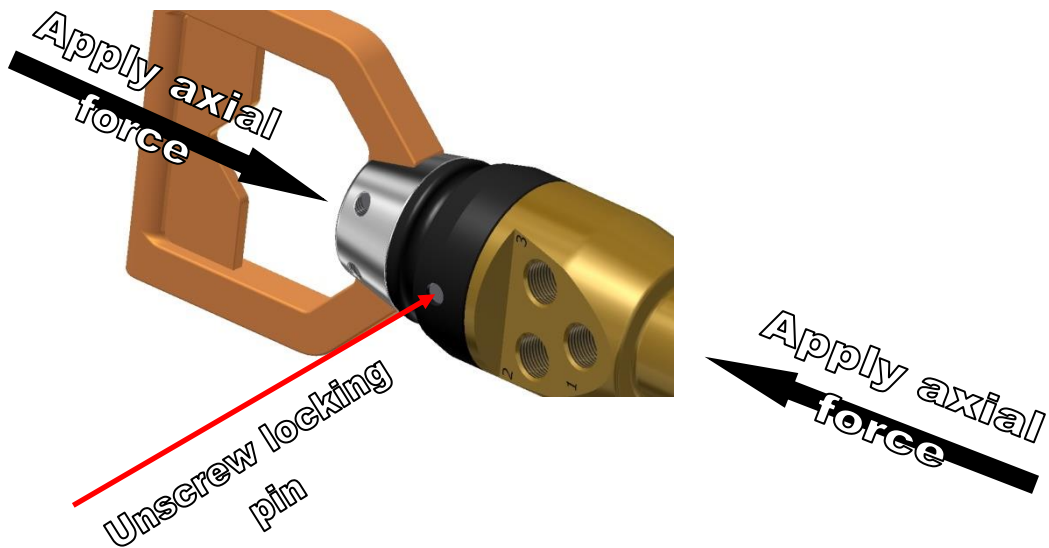

Figure12 Flex joint installation

5.5. SPARE PARTS

For available spare parts, please visit: <http://e-sea.bluelogic.no/main.aspx>

6. STORAGE AND TRANSPORT

6.1. PRESERVATION FOR STORAGE

No.	Description	Chk/Verified
01	Visual inspect the Hot Stab for damages and wear.	
02	Ensure correct post dive sequence followed (see above sections)	
03	Apply preservation oil and secure in storage box.	

6.2. TRANSPORT

No special precautions are needed for transport. However, the following should be verified:

Correct packing; preferably by use of aluminium transport box

Verify the following

1. Sender Name and Address clearly visible
2. Receiver Name and address clearly visible
3. Inventory list correct filled out